

Content

Page

1	General references for the operating instructions	3
1.1	Intended use	3
1.2	Safety regulations	4
1.3	Icons used	4
1.4	Warnings	4
2	System description	5
3	Transportation, storage and assembly preparation	6
4	Assembly of the modules and components / References for the assembly instructions	7
4.1	Example of the assembly sequence of a conductor rail 0832	7
4.2	Reference to additional assembly instructions	9
5	Start-up and operation	10
6	Maintenance	11
6.1	In general	11
6.2	Safety regulations	11

Operating instructions



Conductor rail program 0832

System description

6.3	Warnings	11
6.4	Tool and accessories.....	12
6.5	Maintenance plan	12
6.6	Start-up after maintenance.....	14
7	Cleaning.....	15
7.1	In general.....	15
7.2	Safety regulations.....	15
7.3	Selection of the cleaning method / Selection of the cleaning agents	15
7.4	Insulation measurement	15
7.5	Description of the individual products.....	16
7.6	Environmental compatibility / Risks.....	17
7.7	Use and application	17
7.8	Packaging / Processing / Supply source	18
8	Troubleshooting and repair	19
9	Decommissioning, dismantling and disposal	20
10	Glossary.....	23

Reprints and reproductions, even in excerpts, are only permitted with our approval.

© Conductix-Wampfler AG / 2009

1 General references for the operating instructions

These operating instructions describe the structure of the conductor rail system 0832. Various system configurations are possible. The particular conductor rail system was already designed during the selection of the components and includes tolerances and temperature fluctuations within a specified range as well as additional system-related parameters.

Information (such as the layout, drawing and catalog KAT0832-0001-E) must be available to the installer of the system, in order to include it accordingly in the planning, assembly and start-up.

1.1 Intended use

Conductor rail system 0832 was developed specifically for AS/RS (Automated Storage/Retrieval System) and can only be used in enclosed areas!

Other uses must be discussed with the local representation of Conductix-Wampfler.

- The general application parameters and technical data may be derived from catalog KAT0832-0001-E.
- The tolerance within which 0832 must be assembled depend on the tolerances that the mounting surfaces present. The tolerances within which the current collector moves with the conductor rail is ultimately relevant. These must be checked and possibly adjusted prior to start-up after setting up the overall system.
- The system axes are defined as follows:
 - * X-direction = Aisle direction
Travel of storage retrieval system
 - * Y-direction = Height direction / vertical
 - * Z-direction = Travel from the aisle into the rack
- The max. tolerances of the current collector to the conductor rail are:
 - * X-direction = max. travel up to 200 ± 20 mm forward
End of the conductor strips
 - * Y-direction = ± 15 mm / ± 8 mm recommended
(± 5 mm for tangential entries)
 - * Z-direction = ± 10 mm / ± 5 mm recommended



The system is designed for a quick and secure assembly. The primarily used screw connections are M8; wrench size (SW) = 13 mm. A torque of 25 Nm applies for these connections, provided no other deviating values have been mentioned at the relevant location.

1.2 Safety regulations

Safety regulations known from relevant compendiums of guidelines and regulations and country-specific specifications for working on electrical systems apply (i.e. VDE/UVV/VBG4).

Safety regulations for accessing and entering the systems defined by the respective system operator apply.

Work on the conductor rail may only be performed by specifically trained skilled personnel in correspondence with relevant technical standards, regulations and laws.

Only qualified electricians may perform work on the electrical system of the facility in correspondence with the relevant electrical standards (such as VDE, IEC) and country-specific regulations and laws.

Conductor rails are a part of the electrical system and must therefore be checked repeatedly and routinely according to the accident prevention regulations (i.e. VBG4).

Only **original Conductix-Wampfler spare parts** may be used! Conductix-Wampfler cannot take any responsibility for a perfect and safe operation when using other components.

1.3 Icons used



Warning of general injury risks and property damages



Warning of hazards from crushing



Warning of injuries from electric shock



Notes for a proper operation

1.4 Warnings



Risk of injuries from electric shock!

Prior to working on the conductor rail, the system must be switched off by using the master switch and secured against unauthorized and/or accidental restarting. If a master switch is not available in special cases, the system must be switched off according to the specifications of the AS/RS manufacturer. First, check that the connected parts are free from voltage, then ground these and short circuit. Insulate adjacent live parts!

An insulation test in correspondence with local technical standards, regulations and laws must be performed prior to each start-up.



Risk of injuries between stationary and movable parts of the system!

The system must be switched off with the master switch prior to working on the conductor rail!

Conductor rail program 0832 System description

2 System description

- The conductor rail program 0832 is an extendable conductor rail feed-in system. The expansions are accomplished by connecting individual conductor rail sections via pick-up guide transits, insulation separating points or conductor strip connectors.
- The positions of power feeds, expansion elements and possibly the anchor point are important for the assembly of the individual sections – if available. The installer of the section must know the planning guidelines (such as the layout, drawing, etc.), in order to include the assembly direction and sequence.
- It is important for the proper setting of the section to know the temperature guidelines and the assembly temperature. If the conductor rail system expands freely in one direction (i.e. without anchor points), the gap adjustment of the expansion element is accomplished according to the table in catalog KAT0832-0001-E. If one or several anchor points are available in the conductor rail system, please obtain the coordination of the gap adjustment of the expansion element with Conductix-Wampfler.
- All relevant sections of these operating instructions must be read completely prior to starting the work. In the event of any doubts, please contact Conductix-Wampfler!

Illustration of the support profile

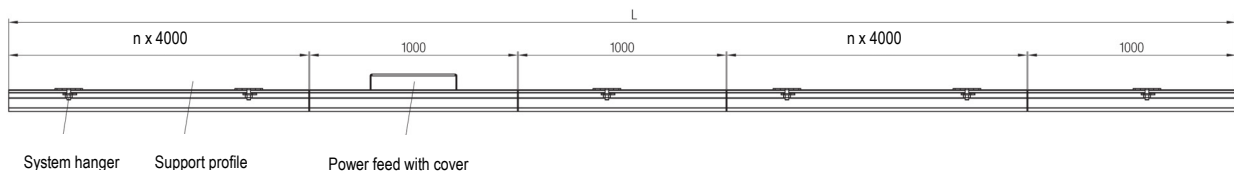
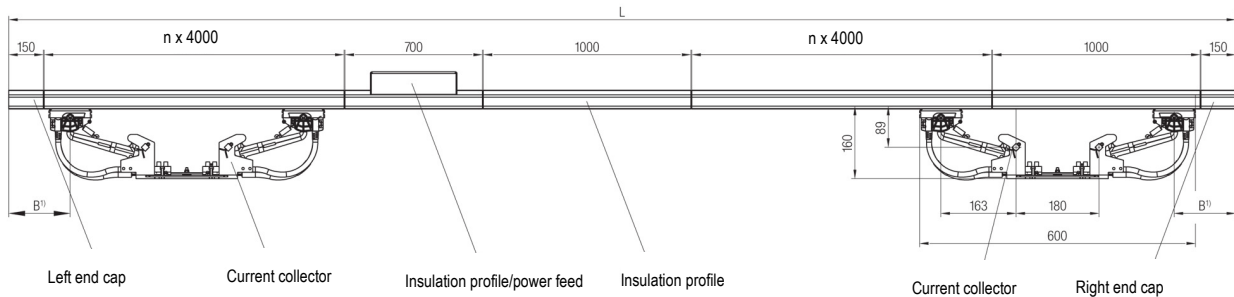
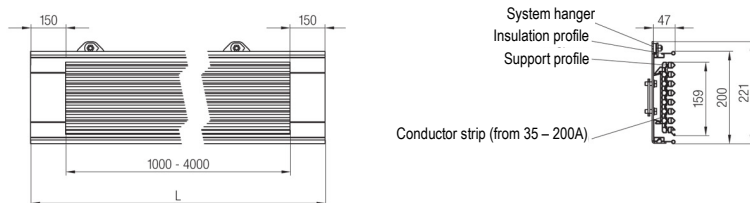

Illustration of the insulation profile



1) min. 200 + expansion path

Nominal offset of the insulation and support profile changeover



The system modules and tools are described in operating instructions BAL0832-0002-E. It is included in the basic module.

3 Transportation, storage and assembly preparation



- Modules (basic and extension module) are prepackaged for transportation and storage. They must be protected from moisture.
- Note the labels when entering into the aisle: **"The assembly position sets the feed in direction!"**
- A wheel set can be used for transporting, if necessary (refer to tool set "Profi" or BAL0832-0002-E)!
- Only unpack directly at the assembly site. All of the required parts are enclosed with the modules in the proper quantity!

The basic and extension module can be transported into the individual aisles with the aid of a wheel set (only included in the tool set "Profi"). The aisle marking on the top must be noted! The arrow points to the aisle side to which conductor rail system 0832 will be assembled. The extension module should be ideally placed in the center of the aisle. This results in the shortest travel.

The basic module is placed in the area of the power feed.

Do not remove the protective covers until immediately prior to the assembly!

The individual poles of the insulation profile are intended for feeding conductor strips (compare conductor strip module).

All modules must be protected from contamination and moisture.

4 Assembly of the modules and components / References for the assembly instructions

4.1 Example of the assembly sequence of a conductor rail 0832

1. Install the rack consoles (if included in the delivery) according to the system layout.

The assembly instructions MV0832-0001-E are enclosed in the package of the consoles.



Consoles are used when the conductor rail 0832 is not assembled to existing rack consoles.



2. Assemble system hangers for various rack consoles.

MV0832-0002-E is enclosed in the package of the system hangers.

The system hangers are assembled on the rack consoles or the pre-assembled consoles.

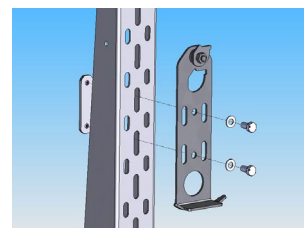

3. Assemble support profiles with insulation profiles.

MV0832-0003-E is enclosed in the package of the basic module.

The support profiles are attached to the system hangers and screwed together with the connectors. The system layout must thereby be observed.

The insulating profiles are pre-assembled on the support profiles and can be easily moved.

The connection of the insulating profiles is described in assembly sequence 7!



Assembly sequences 3 and 4 can be interchanged – depending on the system!

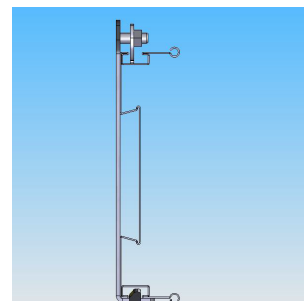

4. Assemble the power feed.

MV0832-0004-E is enclosed in the package of the basic module.

The power feed is assembled according to the system layout.

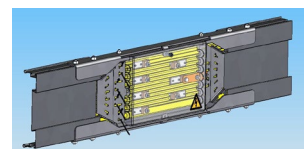

5. Assemble the expansion element.

MV0832-0005-E is enclosed in the package of the expansion module.

The expansion module also serves the adjustment of the expansion of the insulating profile during temperature fluctuations. The position is defined in the system layout.

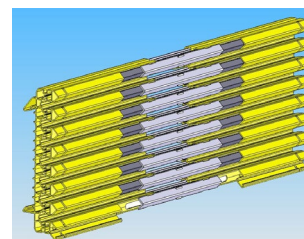

Conductor rail program 0832

System description

6. Conductor strip feed.

MV0832-0006-E is enclosed in the package of the basic module.

The conductor strips are assembled according to the system layout.



The allocation of the cross-sections to the poles must be observed!

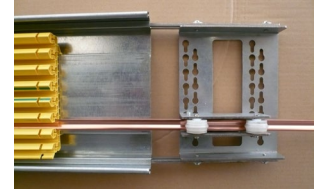

7. Assemble the insulation profile (including the connection of the insulation profiles).

MV0832-0007-E is enclosed in the package of the basic module.

The insulation profiles are plugged together with the connector parts.

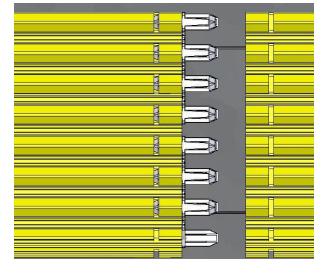

8. Assemble the insulation separating point.

MV0832-0008-E is enclosed in the package of the insulation separating point.

The insulation separating point typically serves the electrical separation of system segments.

The installation is performed according to the system layout.

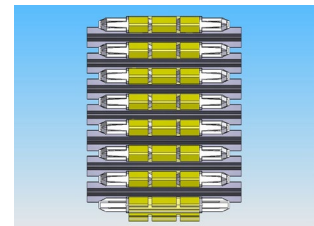

9. Assemble the end cap (left and right).

MV0832-0009-E is enclosed in the package of the basic module.

The end caps serve the end and the contact protection on the conductor rail ends.

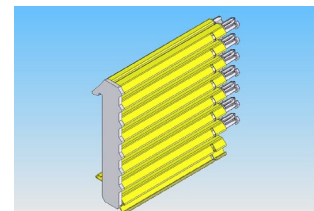

10. Assemble the current collector for the stacker crane (with and without change support).

MV0832-0010-E is enclosed in the package of the current collector.

The current collector must be mounted to the stacker crane according to the system layout.

The installation dimensions with the approved tolerances must be observed in compliance with the projection documents and technical data in KAT0832-0001-E.

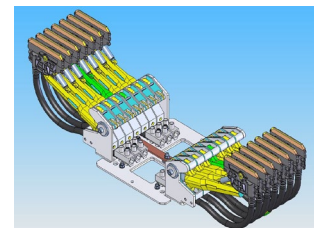

11. Assemble the positioning module (system manufactured by Leuze).

MV0832-0011-E is enclosed in the package of the positioning module.

The positioning module enables to quickly incorporate the LEUZE barcode strip for designating the position with barcode readers. It is assembled according to the projection documents.

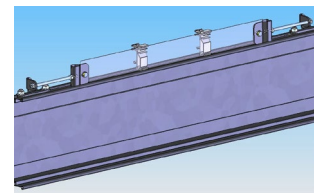

Conductor rail program 0832

System description

12. Assemble the conductor strip-connector module.

MV0832-0012-E is enclosed in the package of the conductor strip-connector module.
The module serves the connection of conductor strips in systems with system lengths beyond the max. roll length of the conductor strips. It is assembled according to the projection principles.

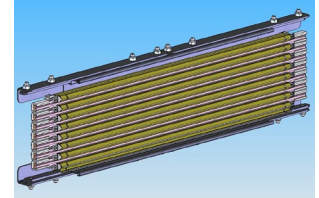

4.2 Reference to additional assembly instructions

13. Assemble the pick-up guide.

MV0832-0013-E is enclosed in the package of the pick-up guide.

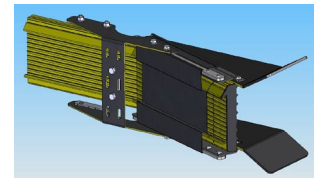

14. Assemble the repair module.

MV0832-0014-E is enclosed in the package of the repair module.
The repair module serves the exchange of a segment of the conductor rail in case of accidental damages.



15. Tools

MV0832-0015-E is enclosed in the package of the basic module.



5 Start-up and operation



CAUTION! Machine/property damages!

Only trained personnel may perform the start-up!

The following items must be checked prior to start-up:

- Is the conductor rail system completely assembled?
- Are damaged components installed?
- Are all components clean?
- Max. hang-up distance of 3.2 m on the rack consoles or consoles
- Proper fit of the support profiles with the adapters and system hangers
- Are all insulating profiles snapped into the support profiles?
- Are the connecting elements, insulating connectors, clamping sheets and connector pins available on all change overs?
- Are the clamping sheets centered on all support profile change overs and are the nuts tightened?
- Proper electrical connection of the power feed
- Proper electrical connection of the current collectors (including the strain relief to be attached by the customer)
- Are conductor strips inaccessible with fingers
- Are end caps available
- No scattered parts in the operating area (all assembly tools removed)
- Proper fit of the current collector or change support, if available, on the stacker crane
- Securing the change support – if available – with the cable tie
- No conflict of the current collector lines during all operating conditions
- Insulation test in correspondence with local technical standards, regulations and laws

The movement of the individual current collectors must be evaluated over the entire travel section in manual or “slow travel” (compare chapter 1 for installation tolerances) and potential conflicts must be eliminated.

Conductor rail system 0832 (EcoClickLine) can be operated at the following parameters after a successful start-up:

- Rated voltage: max. 690 V / USA/Canada --> 500 V
- Approved ambient temperatures are system related (from -30 to +55°C)
- The difference of the usage temperature is system related (max. 50 K)
- Max. travel speed on the track: 600 m/min
- Max. travel speed in the pick-up guide area: 80 m/min

It must be verified during the operation that no personnel is located in the aisle.



CAUTION! Machine/property damages!

Damages of the conductor rail system due to improper assembly!

6 Maintenance

6.1 In general



CAUTION! Machine/property damages!

A routine and sufficient maintenance is necessary for the proper function of the conductor rail. It prevents any risk of the operational safety and the contact protection and is the requirement to maintain the warranty. An intermediate maintenance may become necessary at special events.

6.2 Safety regulations

Safety regulations known from the relevant specifications and country-specific regulations for work on electrical systems apply when performing maintenance (such as VDE/UVV/VBG4).

Safety regulations for accessing and entering the systems defined by the respective system operator apply.

Maintenance and repairs on the conductor rail may only be performed by suitably trained skilled personnel in correspondence with the relevant technical standards, regulations and laws.

Only qualified electricians may perform maintenance and repair on the electrical system in correspondence with the relevant electrical standards (such as VDE, IEC) and country-specific regulations and laws.

Conductor rails are a part of the electric system and must therefore be repeatedly and routinely checked according to the accident prevention regulations (i.e. VBG4).

Only **original Conductix-Wampfler spare parts** may be used. Conductix-Wampfler cannot assume any responsibility for a perfect and safe operation when using other components.

6.3 Warnings



CAUTION! Risk of injuries due to electrical current

The system must be disconnected with the master switch prior to the inspection, maintenance, repair or dismantling the conductor rail system and/or secured against unauthorized, accidental and/or mistaken restarts. If a master switch is not available in special cases, the voltage cutoff must be performed according to the system manufacturer's guidelines. First, check the disconnected parts that they are disconnected, then ground and short circuit.

Insulate adjacent live parts which are energized!

An insulation test in correspondence with the local technical standards, regulations and laws must be performed prior to each start-up.



CAUTION! Risk of crushing between stationary and movable parts of the system!

The system must be switched off with the master switch prior to the inspection, maintenance, repair or dismantling!

Conductor rail program 0832

System description



CAUTION! Health hazard due to carbon dust!

Abrasion of the collector shoe accumulates in the conductor rail system and on the floor. This dust is very fine and is classified as harmful. Personal protective gear, such as safety glasses, dust mask and gloves are mandated for all work on the conductor rail system, especially for cleaning. Contact with mucous membranes must be avoided. Do not inhale the dust. Clean skin surfaces with water and appropriate cleaning agents after work. Rinse with clean water in case of eye contact. Dust deposits can be raised and inhaled during maintenance work. A dust mask must be worn!

6.4 Tool and accessories

Conventional tools (metric) and measuring instruments are used for the maintenance of the conductor rails. A **caliper gauge** is required for measuring the collector shoe content. A **spring balance** with a measuring range from 0 to 20 N or 0 to 50 N is used to define the contact pressure of the collector shoe.

6.5 Maintenance plan

A **maintenance contract is recommended**, which controls the maintenance and inspection. Maintenance and inspection is performed by Conductix-Wampfler service personnel or authorized local service partners of Conductix-Wampfler. The advantages of a maintenance contract are an increased availability of the system and a cost-effective, as well as precise performance of the maintenance work by trained personnel.

Maintenance cycle: 6 months (1st maintenance for new systems: 4 weeks after start-up).

Current collector:



CAUTION! Risk of injuries by electric current!

Visual inspection of the collector shoe due to abrasion in the contact area. Replace the current collector head, when the minimum height of the collector shoe reaches 4 mm on at least one point opposite the collector insulation (compare illustration below). This is the case at least after 15,000 km when performing routine maintenance. Coverage of more than 30,000 km is possible at a low contamination degree and clean deburred transit points (in the areas of the connector module, repair module, insulation separating point and pick-up guide).

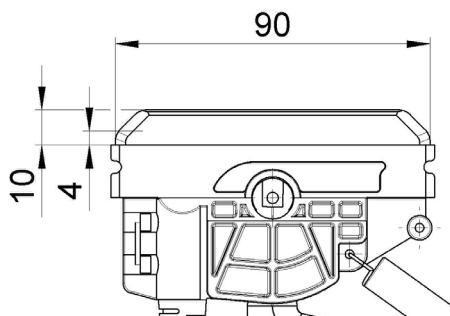

Visual inspection of the collector insulating for cracks and abrasion points. Replace the current collector head, if the insulation is scraped through and the collector shoe is visible or if the collector insulation displays cracks.

Conductor rail program 0832

System description

Visual inspection of the connector lines for kinks, damages of the insulations or the stranded conductors, wiring, plug connections and screw connections (European-style terminal strips). Replace the current collector head, if the connecting line has one of the described damages.

Checking the contact pressure: attach a suitable spring balance on the current collector arm, possibly near the joint of the current collector head. Pull the current collector head (in z-direction) vertically from the conductor rail with the aid of the spring balance. Reading the measurement: if the collector shoe varies from the conductor surface!

The contact pressure must be between 7 and 12 N. The mounting position on the AS/RS (Z direction) must be adjusted in the event of deviations.

Checking all connecting and fuse elements (incl. cable ties for change support, if available), as well as the easy movement of each individual current collector arm; if necessary, replace.

Check the stroke and side tolerance of the current collectors with the conductor rail (compare chapter 1). Adjust the attachment position on the AS/RS, if necessary.

Conductor strip and insulation profile:



CAUTION! Risk of injuries by electric current!

Visual inspection of the **conductor strips** for wear, damages, contamination or burnt spots; replace the conductor strip, if necessary. Verify that the conductor contact areas are completely free of burrs. Burrs on junctions, connector module, repair module, insulation separating point and pick-up guide may result in an increased carbon loss.

Contamination on the conductor area can be removed mechanically with a cleaning brush. The local Conductix-Wampfler service partner will provide information concerning the cleaning brushes.

Visual inspection of the **insulation profile** for wear, damages, contamination or burnt spots; clean or replace the insulation profile, if necessary.

Verify that there are no bottlenecks in the individual poles of the insulation profile (i.e. due to adhering contamination or offset due to the overheating of the conductor rail system). Clean and replace the insulation profile, if necessary.

Visual inspection for areas with local overheating (possibly with a thermal imaging camera, if available).

Manually check the movability of the insulation profiles with a loose current collector.

Verify that the insulation of the insulation profile is not obstructed by foreign bodies (chips, liquids, contaminations, etc.) (Risk of short circuits).

Expansion element, connector module, repair module, insulation separating point and pick-up guide:



CAUTION! Risk of injuries by electric current!

Abrasion may accumulate in the individual poles. This must be removed with a vacuum cleaner or a brush. It must be guaranteed that the covers of the expansion element and the connector or repair module are snapped in. Snap in or replace the covers, if necessary.

Verify on the connector or repair module that all conductor strip change overs are free from gaps; if necessary, shift the conductor strips and secure these again with the stud screws.

The distance between the individual conductor strip ends and the insulation separating point or the pick-up guide may not be 0 mm, but may also not have a gap greater than 30 mm (refer to the respective assembly guidelines). Shift the conductor strips, if necessary.

Check the plastic transit strip of the insulation separating point. Replace the separating point in the event of excessive wear or a loose change over strip.

Check the pick-up guide transit by manually or slowly moving the AS/RS. Clean or readjust, if necessary.

Check the stability of the pick-up guide. If necessary, retighten or replace.

Conductor rail program 0832

System description

Support profile, system hanger and adjustments for rack consoles:



CAUTION! Machine/property damages

Visual inspection for damages, breakages, contamination or corrosion; if necessary, replace. Check the height of the horizontal contact of the current collector arms (Y direction). Adjust, if necessary.
Check the even course of the support and insulation profile (compare chapter 1 for tolerances) and adjust to the system hanger or the adapter, if necessary.
Check screw connections and retighten, if necessary.
Check, if the conductor rail system bends partially in Z direction during the operation. The max. deflection during the operation equals 15 mm. This may occur on support profile change overs between rack consoles or consoles. Greater deviations on the change over points may be reduced with a reinforcement bracket.

Power feed:



CAUTION! Risk of injuries by electric current!

Only skilled electricians who know and observe the relevant accident prevention regulations may open and close, as well as working without covers.
Visual inspection for wear, damages, contamination, burnt spots or corrosion; possibly replace the components concerned.
Visual inspection of the connecting lines for kinks, damages of the insulation or the stranded wire. The wiring installation as well as the plug or screw connections must be checked.
Check screw connections and retighten, if necessary.
PE conductor: visual inspection; continued inspection within the system and on interfaces, measurement of the grounding resistance.
Phase: measure the insulation resistance.
Visual inspection for areas with local overheating (possibly with a thermal imaging camera, if available).

End caps:



CAUTION! Machine/property damages

Visual inspection for wear, damages, contamination, burnt spots or corrosion; replace the components, if necessary.

6.6 Start-up after maintenance

Prior to restarting, verify that

- all work was completed according to chapter 6.5.
- the system was inspected and tools, scrap, etc. are removed from the process area.
- that personnel is not located in the process area.
- the guidelines of the system manufacturer have been observed.

A trial run of the entire system must be performed.

The system must be observed during the first operating hour.

7 Cleaning

7.1 In general

Cleaning is a part of the maintenance of the conductor rail system. Cleaning prevents a risk to the operating safety as well as the protection against contact.

Cleaning targets the following:

- Removing the dust on collector shoes.
- Removing the dust of the conductor rail insulations.
- Removing insulating layers from the conductor surface (oxidation of the conductor surface, condensate and film development).
- Removing extensive contamination from the surrounding system (dust, fluids, such as oils and syrup, etc.).

The cleaning process assumes an inspection of the conductor rail system by skilled personnel from the Conductix-Wampfler AG.

Exempt are only repeated cleaning processes within the scope of maintenance plans that have been authorized by the "conductor rail engineering department" of the Conductix-Wampfler AG.

7.2 Safety regulations



CAUTION! Risk of injuries by electric current!

Safety regulations known from relevant regulations apply for work on electrical systems.

The safety regulations issued by the respective system operator apply for entering and working in systems.

The relevant safety data sheets and process specifications apply for the use of cleaning agents.

7.3 Selection of the cleaning method / Selection of the cleaning agents

The cleaning method and cleaning agents used therein must be coordinated with the "conductor rail engineering department" of the Conductix-Wampfler AG prior to their application.

Disassembly/reassembly/adjustment of the conductor rail system or parts of the conductor rail system within the scope of cleaning requires the approval of the "conductor rail engineering department" of the Conductix-Wampfler AG.

7.4 Insulation measurement

In order to determine the necessity for cleaning, and/or the success of cleaning the conductor rail system, measurements of the insulation resistance before/after cleaning must be performed and recorded in a protocol.



CAUTION! Risk of injuries by electric current!

The following work must be performed by a skilled electrician!

Prior to performing work on the conductor rail system, it must be disconnected and secured against unauthorized, accidental and/or mistaken restarting!

Conductor rail program 0832

System description

In order to prevent incorrect measurements, the conductor rail system must be insulated, i.e. on the power feeds belonging to the conductor rail system, as well as on the current collectors/terminal boxes belonging to the conductor rail system.

The current collectors must be in the operating position.

Deviations from these guidelines based on the respective system/installation or the selected measuring method must be noted in protocol (drawing of the measured section with the enclosed system components).

Entrances/transits and insulation separating points must be included in the definition of the measured section. The conductor rail system must therefore be divided into individual measuring sections.

The following insulation resistances must be determined:

- Between adjacent poles.
- Between each pole and ground.

The arrangement of the poles and/or the designation of the poles must be recorded in the protocol (possibly with a drawing).

The fluctuation range in deviating insulation resistances must be determined via repeated measurements.

The following applies for low voltage systems (rated voltage < 1000 V):

- The insulation resistance is measured with provided ohmmeters, which operate with DC voltage.
- The **insulation resistance** in systems with \leq a **rated voltage of 500 V** \geq must equal **0.5 M Ω** .
The **DC voltage of the measurement must equal 500 V**.
- The insulation resistance for systems with a **rated voltage of > 500 V** must equal \geq **1.0 M Ω** .
The **DC voltage of the measurement must equal 1000 V**.

Sufficient insulation resistances are a requirement to restart the system.

7.5 Description of the individual products

- Vacuuming and removing rough residue
- Cleaning brush / sand paper with a grain of 180 or finer.
- Damp cloth without the addition of a cleaning agent.
- Cleaning concentrate "Rivolta B.W.R. 210":
Low alkaline, biodegradable, non-combustible, physiologically harmless cleaning concentrate with a pleasant odor / insulating residue!
- High performance cleaner "Rivolta S.L.X.-Top":
Puncture proof, free of residue, evaporating, free of halogen-hydrocarbons, odorless, unmarked according to "Ordinance on hazardous substances", versatile cleaning concentrate.
- "Rivolta O.C.X. oxide dissolver":
Dissolves oxide and sulfide layers, resinified oils, greases and mineral abrasion; must always be cleaned afterward with S.L.X.-Top.

7.6 Environmental compatibility / Risks

	B.W.R. 210	S.L.X.-Top	O.C.X. oxide dissolver
Biodegradable	At more than 97%	-	-
Flashpoint	Non-combustible	> 55°C - class A III	> 65°C - class A III
Identification according to "Ordinance on Hazardous Substances"	Not required	Not required	Not required
Storage	In plastic containers at room temperature	In sufficiently ventilated rooms at room temperature, close containers tightly!	In sufficiently ventilated rooms at room temperature, close containers tightly!

7.7 Use and application

Start each cleaning process initially with the weakest possible cleaning agent for the contamination found (compare table below, left column). The cleaning agent of the following column should only be used if no satisfactory result could be achieved.

Contamination / cleaning agent	Damp cloth	Fine brush / fine-grained sanding paper	B.W.R. 210	S.L.X.-Top	O.C.X. oxide dissolver
Dust, carbon abrasion or light contamination	Insulation / conductor	Conductor / carbons	Insulation / conductor		
Greasy, oily, sooty or other contamination			Insulation / conductor	Conductor / carbons	
Corrosion		Conductor			Terminal / connector / conductor
Other			Release for food-industry; <u>process only cold!</u>	<u>Affects plastics!</u> Only for cleaning metal parts	

7.8 Packaging / Processing / Supply source

	B. W. R. 210	S.L.X.-Top	O.C.X. oxide dissolver
Packaging	Loose items	Loose items / spray can	Loose items / spray can
Processing	Mix 1:50 / processing via a spray process or high-pressure washer (lance distance > 0.7 m) <u>Rinse cleaned areas with water.</u> Caution: Only restart the system, if it is verified that the water is completely evaporated (⇒ Risk of short-circuits!)	Undiluted with airless electrical spray guns / airless high-pressure washers	Spray by using aerosol cans / undiluted with airless electrical spray guns / wait for 15 - 20 min Caution: Always clean with S.L.X.-Top afterward
Supply source	Bremer & Leguil GmbH - Am Burgacker 30 - 42 - 47051 Duisburg / Germany Tel.: + 49 (0) 203 99 230 Fax: + 49 (0) 203 25 901		

8 Troubleshooting and repair

Defects that occur in reality are, as far as known to us, listed in the table below and are supplemented with repair measures. Repairs may only be performed by qualified personnel.

Defect	Troubleshooting	Repair
Angular abrasion of the collector shoes	Bushing clamps not installed free from rotation, kinking or direction force	Assemble original current collector head by Conductix-Wampfler
	Sufficient ease of movement of the current collector heads is not guaranteed	
	Bundling the individual terminals, for example with cable ties	
Side abrasion of the collector insulation up to the collector shoe	The current collector contact widths are reduced in individual poles of the insulation profile due to overheating of the conductor rail system	Replace the insulation profile. Check, if conductor strips used are suitable
	Incorrect height adjustment of the current collector (Y-direction)	Replace current collector heads; properly adjust the height of the current collector
Excessive wear of the collector shoes	Abrasion points on transits, such as the connector module, repair module, insulation separating point or pick-up guide	Deburr sharp-edged transits with a file, air grinder or sanding paper
	Conductor strips contaminated or with burnt spots	Cleaning according to chapter 7.7; possible replacement of the conductor strips
	Excessive contact pressure of the current collectors	Inspection according to chapter 6.5. If the distance between the AS/RS mount and the conductor strip is too small, adjust according to MV0832-0010-E
Interruption of the power feed or the data transmission	Power feed is not properly connected	Tighten all screws
	The conductor strip of a pole at the power feed is not conducted through the clamping piece	Pull out the conductor strip and reinsert again; if necessary, replace the conductor strip
	Insufficient contact pressure of the current collectors	Inspection according to chapter 6.5, if the distance between the AS/RS mounting is too great, adjust according to MV0832-0010-E
	Pressure piece for the current feed mounted incorrectly or not centered at the connector module or the repair module	Align clean and tighten the setscrew; check the assembly situation according to MV0832-0012-E or -0013 -E
	The conductor strip gap at connector module or repair module is too great	Push the conductor strip to the center to block and tighten the setscrews
	The distance of the double current collectors is too small in a pole so that both current collector heads are simultaneously on the insulation separating point	Enlarge the distance of the double current collectors
	Current collector is not properly connected	Tighten all screws
Conflict with the components of the system	Attach all components concerned free of conflicts; possibly inspect the system layout. Replace damaged components	

Conductor rail program 0832

System description

Defect	Troubleshooting	Repair
Insulation profile detaches from the support profile	The insulation profile can detach from the lower flexible snap hook when overheating the conductor rail system	Replace the insulation profile. Check, if conductor strips used are suitable
	Individual conductor strips with a larger cross section were not properly aligned when inserted and pull the insulation profile from the support profile at the beginning/end of the system	Pull out the conductor strips and align when pulling in; possibly replace the insulation profiles at the start/end of the system
The current collector has detached itself from the hange support	The interlock is not properly snapped in	Properly assemble the current collector as described in MV0832-0010-E
	Fuse with cable tie is missing	
The current collector or the change support rattles	The screw connection to the AS/RS is loose	Tighten the screw and secure against detaching

9 Decommissioning, dismantling and disposal

Short-term decommissioning

If the conductor rail system is not used during a period of 3 weeks max. and no personnel has moved in the aisle within this time (traversing range of the AS/RS), no actions are required. The system is ready for use.

Long-term decommissioning

If the conductor rail system will not be used after a period of 3 to 8 weeks max. or if personnel moved in the aisle during a decommissioning (traverse range of the AS/RS), chapter 6.6 (start-up after maintenance) must be observed.

If the conductor rail system is used after a period of 8 weeks, chapter 6 must be observed and the appropriate maintenance must be performed.

Dismantling

It is recommended to perform the dismantling in the described sequence.

Dismantling the positioning module:



CAUTION! Risk of cutting!

The potentially available barcode strips have sharp edge and may result in cuts.

Slacken the tightened barcode strip by shifting the tension unit (with the threaded rod). Remove the screw of the tension unit, in order to remove the barcode strip (compare MV0832-0011-E). Release the barcode strip from the individual band holders. Unscrew the holders of the tension units from the support profile!

Dismantling the pick-up guides:

Remove the attachment on the console. Remove the 4 nuts on the support profile attachment. Press in the insulating connectors with the aid of the dismantling tool from the tool kit and remove the pick-up guide (compare MV0832-0015-E).

Dismantling the conductor strips:

Remove the covers on the back of the power feed (compare MV0832-0004-E), connector module (compare MV0832-0012-E) and repair module (compare MV 0832-0013-E) and all setscrews. Pull out the conductor strips to the ends of the system.

Conductor rail program 0832

System description

Dismantle the insulation profiles, anchor points, expansion elements and insulation separating points:

Remove the bar code holder (of the positioning module). Release the insulating connectors with the aid of the dismantling tool from the tool kit (compare MV0832-0007-E). Pull out or -screw out the insulating profiles, in order to remove them from the support profiles. Unscrew the anchor points, remove the expansion elements and insulation separating points.

Dismantling the connector and repair modules:



CAUTION! Risk of cuts and contusions!

Protective gloves and work safety shoes are recommended for this work segment. The support profiles have sharp edges and may result in cuts or contusions.

Release the nuts for the support profile connection on both sides 8 x (4 x top and 4 x bottom) and push the support profile connector inward (compare MV 0832-0012-E and MV 0832-0013-E)!

Hold the connector and repair modules during dismantling. Falling parts may result in injuries!

Dismantling the support profiles and power feed:



CAUTION! Risk of cuts and contusions!

Protective gloves and work safety shoes are recommended for this work segment. The support profile ends have sharp edges and may result in cuts or contusions.

Remove the terminals from the power feed. Release the nuts on the clamping sheets (top and bottom) on all support profiles (compare MV0832-0004-E). Release the excenter of the system hangers separately for each support profile. Pull out or twist out the released support profile. Remove the clamping sheets and the connecting pins (compare MV0832-0003-E). Possibly remove the strip holder of the positioning module. Repeat this process for all support profiles and the power feed!

Hold the power feed during dismantling. Falling parts may result in injuries!

Dismantling the system hangers:

Remove the system hangers with the optionally used adapter system from the console or the aisle support.

Disposal

The owner must dispose the packaging and conductor rail system according to the current national or regional law at the location of the system.

Most of the components can be dismantled and reused.

Exceptions:

- The current collectors (current collector head including the cable) are of composite. They may be returned to Conductix-Wampfler or disposed of as special waste.
- The end caps are of PVC and are bonded with the insulating profile. The insulating profiles of the pick-up guides are bonded with the PVC sliding elements on the miters. The PVC strip sections of the insulation separating point is bonded with the insulating profile. Tangit PVC-U is used for cleaning and bonding all components mentioned. They are disposed of as special waste.

Operating instructions

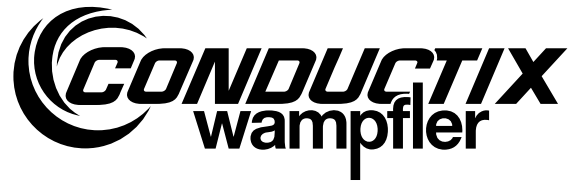

Conductor rail program 0832

System description

The materials of the components and single parts may be derived from the following overview.

Component --> single part	Material
Insulation profile Expansion connector --> black plastic profile End cap cover	PVC
Support profile System hanger Wheel set Current collector --> all metals Change support --> all metals Interlock --> all metals Single current collector -> adaptation sheet Console Feed in aid --> metal Positioning module -> all metals Disassembly tool Power feed --> all metals Uncoil device -> left/right connection plate + round rotating-plates + locking plate + bent plates on the uncoil device Anchor point Connection and repair module -> bracket + connection plate Straightening device --> all metals Saw device --> metal	DX51D+Z
Saw device --> plate	Aluminum
Uncoil device --> most metals	DC04
Power feed --> connection plate for support profile Uncoil device --> plate for hinge screw attachment Straightening device --> axes	S235JR
Interlock --> sleeve	X8CrNiS18-9
Connector pin Positioning module --> plastic holder Straightening device --> rollers	PA66
Insulating connector Expansion element --> spacer + cover Connector and repair module --> front/back cover	PBT
Uncoil device --> plastic guide for conductor strip Feed in aid --> plastic guide	S-GREEN
Conductor strips	Cu-ETP

10 Glossary

Adapter	Connecting piece (consisting of multiple parts) between the console and system hanger
Adapter plate	Additional plate installed if the single current collector is inserted or removed from the opposite side of the collector
Aisle	Aisle in which an AS/RS is changed
Anchor point	Locking the insulation profile to the support profile
Angular abrasion	Uneven wear of a collector from improper use
AS/RS	Abbreviation of Automated Storage/Retrieval System
Assembly	2 or more single parts that are connected together
Assembly temperature	Temperature on site during the assembly of the insulation profile
Barcode bands	Barcodes glued on steel plate strip
Barcode holder	Plastic holder for attaching the barcode bands on supports or insulation profiles
Basic module	Packaging unit with the single use part required for an aisle , such as the power feed
Carbon dust	Abrasion of the collector shoe
Collector change support	Connector piece between the current collector and the AS/RS for quicker installation or removal
Clamping piece	U-profile for connecting conductor strips
Clamping plate	Support profile connector with two pressed studs and removeable nuts
Collector	Consists of collector shoe and collector insulation
Collector insulation	Plastic part for the protection of the live collector shoe and wiring
Collector shoe	Sliding element that collects the current or the data from the conductor strip
Composite	Material mixture
Conductive insert	Conductor strip section for the current or data transmission at a joining point or power feed
Conductor rail	Single or multi-pole conductors in an insulation profile that transmits current or data
Conductor rail system	Contains all Conductix-Wampfler components for the current and data connection that transfer power to a moving storage/retrieval system from a stationary installed power feed
Conductor strip	Electrically conductive or extruded roled section for current or data transmission
Conductor strip connector set	Module (packaging unit) for connecting conductor strips incl. all required connector parts
Conductor strip cross section	Various cross sections between 10 and 50 mm ²
Conductor strip feed in system	Conductor rail system in which the conductor strip is fed into a preassembled insulation profile
Conductor strip module	Packaging unit for a max. of 7 conductor strips of one length (with the same or variable cross sections) for an aisle incl. the matching connecting cable in variable lengths
Connecting cable	Electrical connection between the customer's terminal box and the power feed
Connector module	Packaging unit for connecting conductor strips in long aisles or subsequent extensions of the conductor rail system at known conductor strip cross sections
Connector parts	Single parts or assemblies for connecting system components, such as the conductor strip , insulation profile or the support profile

Conductor rail program 0832

System description

Connector pin	Plastic part for connecting rounded support profiles
Console	Vertical steel elements, to which a conductor rail system can be attached via adapter and/or screws.
Constriction	Reduced width of a pole , which constricts the movement of the collector insulation
Contact	Two components which touch each other (e.g. conductor strip and plastic transfer strip of the pick-up guide)
Contact force	Force that acts from the current collector head on the conductor strip
Current collector	Device on the AS/RS for the current and data transmission of a permanently fixed conductor rail to the electrical equipment of the storage/retrieval system
Current collector head	Assembly consisting of collector and wiring
Disassembly tool	Tool for pressing in the insulating connector to separate the insulation profiles
Distortion	Irreversible deformation to the insulation profile due to overheating
Double current collector	Two sided current collector assembly (can be used with four to seven pole systems)
Earth electrode	Non-insulated electric conductor, which is integrated into the ground as electrical contact area
Earth resistance	Electrical resistance between the terminals of a earth electrode and the ground
Eccentric locking plate	Rotating plate on the system hanger for securing in the support profile
End cap	Located at the beginning and end of a conductor rail system
Entrance	Movement of the current collector head into the pick-up guide
Expansion	Temperature-dependent expansion of the insulation profiles and/or conductor strip
Expansion joint	Connecting piece, which allows the expansion of the insulation profile
Expansion module	Packaging units for all track components (insulating and support profile) including connecting elements
Feed in aid	Tool for threading the conductor strip into the pole of the insulation profile
Feed in direction	Direction (X or Z direction), from which the components of a conductor rail system are transported into the aisle
Gap adjustment	Set the distance of the expansion element according to the assembly temperature and the temperature setting
Hammer head-nut	Special nut for attaching components in the groove of the support profile
Insulating connector	Plug for anchoring the individual insulation profile ends
Insulation profile	Non-conductive protection of live parts
Insulation resistance	Ohmic resistance between electrical conductors i.e. opposite the ground potential
Insulation separating point	Conductor strip interruption, in order to operate individual system areas with or without an additional power feed (maintenance area)
Interlock	Assembly of the collector change support , which is attached on the current collector to simplify the assembly and disassembly
Joining point	Connection point of two insulating profiles or two support profiles
Lift	Movement of the current collector in Z direction
Maintenance area	Conductor rail area for maintenance or repairs, which is free of current and voltage with the aid of an installed insulation separating point
Minimum height	Distance (protrusion) of the collector shoe from the collector insulation
Module	Packaging unit of several single parts and/or assemblies

Conductor rail program 0832

System description

Mounting surfaces	Contact surfaces between consoles, rack consoles and the adapter/system hanger
Operational performance	Permissible wear zone of a current collector head (between the new condition and the minimum height)
Overheating	Excessive heating of the conductor strips due to an incorrectly designed system
Pick-up guide	Alignment aid for entering of the current collectors into a conductor rail system
Plastic transfer strip	Non-conductive spacers glued into the pick-up guide and the insulation separating point for the transit with the collectors
Pole	Electrically conductive connection point
Positioning module	Packaging unit for installing the barcode measurement system
Power feed	Connection to transmit the current or data to each conductor strip
PVC	Polyvinyl chloride
Rack console	Support bracked mounted to the shelf unit to which an additional conductor rail system can be attached
Rear cover	Plastic part that is installed behind the connection or repair module
Repair module	Packaging unit for connecting conductor strips during accidents or subsequent extension of the conductor rail system at unknown conductor strip cross sections
Saw jig	Tool for applying slits (for insulating connectors) precisely into the insulation profile
Single current collector	One sided current collector assembly (can be used with four to seven pole systems)
Single use part	Components, which are used once in standard use in each aisle , such as the power feed and end caps
Storage/Retrieval System	Single-track vehicle for storing, removing or moving items in a high-rise warehouse
Straightening jig	Tool with guide rollers for straightening conductor strip
Support profile	Rolled plate that holds and protects the insulation profile
Support profile connector	Two clamping plates and two connector pins
Support profile joining point	Connection point of two support profiles
Support spacing	Distance (in X direction) between two consoles
System axes	Three axes in which the movement of an AS/RS occurs
System hanger	Plate to screw the support profile to the console (or the adapter)
Tangit PVC-U	Cleaner and adhesive manufactured by Henkel for PVC materials
Temperature setting	Temperature range (minimum and maximum temperature) that may develop in the warehouse
Tension unit	Connecting piece between the barcode band and the insulation profile
Test run	Trial run at reduced speed (maximum stepping speed)
Tool kit „Profi“	Tools that aid in the assembly/disassembly of the conductor rail system including the tool kit „standard“, uncoiling device , wheel set, 13 mm ratchet spanner, transport box and additional feed in aid
Tool kit „Standard“	Tools that aid in the assembly/disassembly of the conductor rail system such as the straightening jig, feed in aid, saw jig, disassembly tool and small parts service packet
Tools	Tool kit Standard or Profi for the assembly of the conductor rail system

Operating instructions

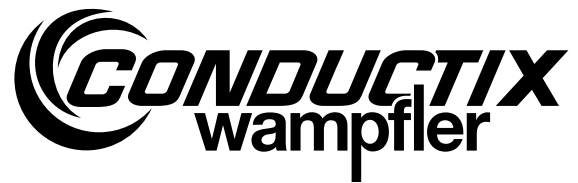

Conductor rail program 0832

System description

Transit	Movement of the current collector over conductor strip joining point (as in the connector and repair modules) or over conductor strip ends (as in insulation separating points and pick-up guides)
Uncoiling device	Conductor strip mounting aid to guarantee a proper strip installation
Usage temperature difference	Temperature range (minimum to maximum temperature) that may occur in the warehouse. Also refer to temperature setting
Wheel set	Transport equipment to move the extension module ergonomically to the assembly location (aisle)
X direction	Aisle direction (horizontal travel of the AS/RS)
Y direction	Aisle height (vertical travel of the AS/RS ; lift unit)
Z direction	Lateral aisle direction (horizontal travel of the AS/RS from the aisle into and out of the shelf)

Note:

The operating instructions are contained in the basic module.

Note:

All illustrations are intended as aids. They may not show the current status of a component of assembly!

Operating instructions

Conductor rail program 0832

System description

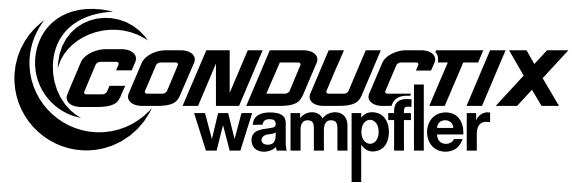

Conductix-Wampfler GmbH
Rheinstraße 27 + 33
79576 Weil am Rhein - Märkt
Germany

Phone: +49 (0) 7621 662-0
Fax: +49 (0) 7621 662-144
info.de@conductix.com
www.conductix.com



Importer for the United Kingdom:
Conductix-Wampfler Ltd.
1, Michigan Avenue
Salford
M50 2GY
United Kingdom

Phone: +44 161 8480161
Fax: +44 161 8737017
info.uk@conductix.com
www.conductix.com